

10th Biannual Joint CNC/CIE and CIE/USA Technical Conference
October 18-20, 2015

Measurement Complications of High Frequency Electricity

C. Cameron Miller and Yuqin Zong
National Institute of Standards & Technology

Waveforms – Before ballast

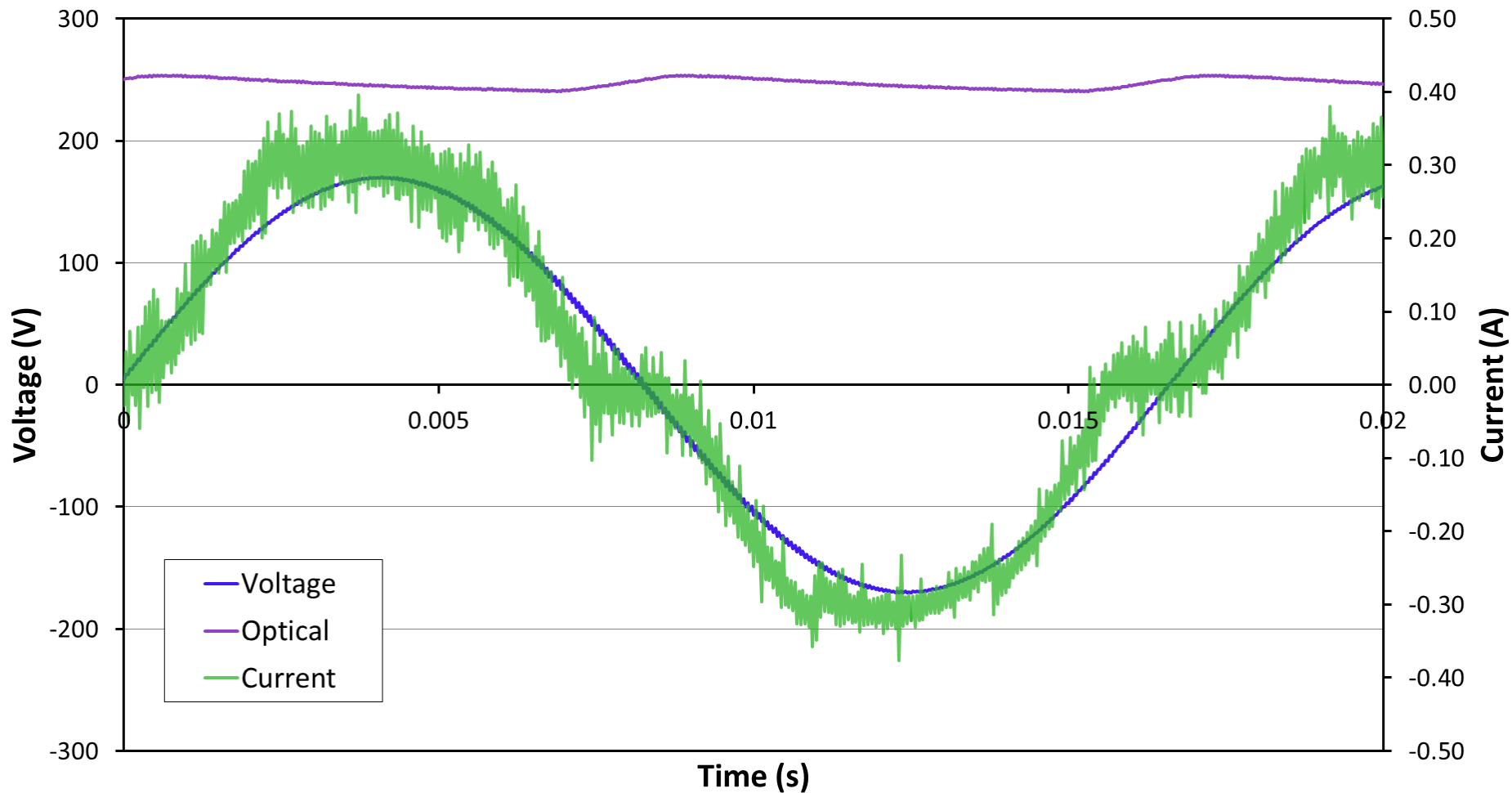

Waveforms – After ballast

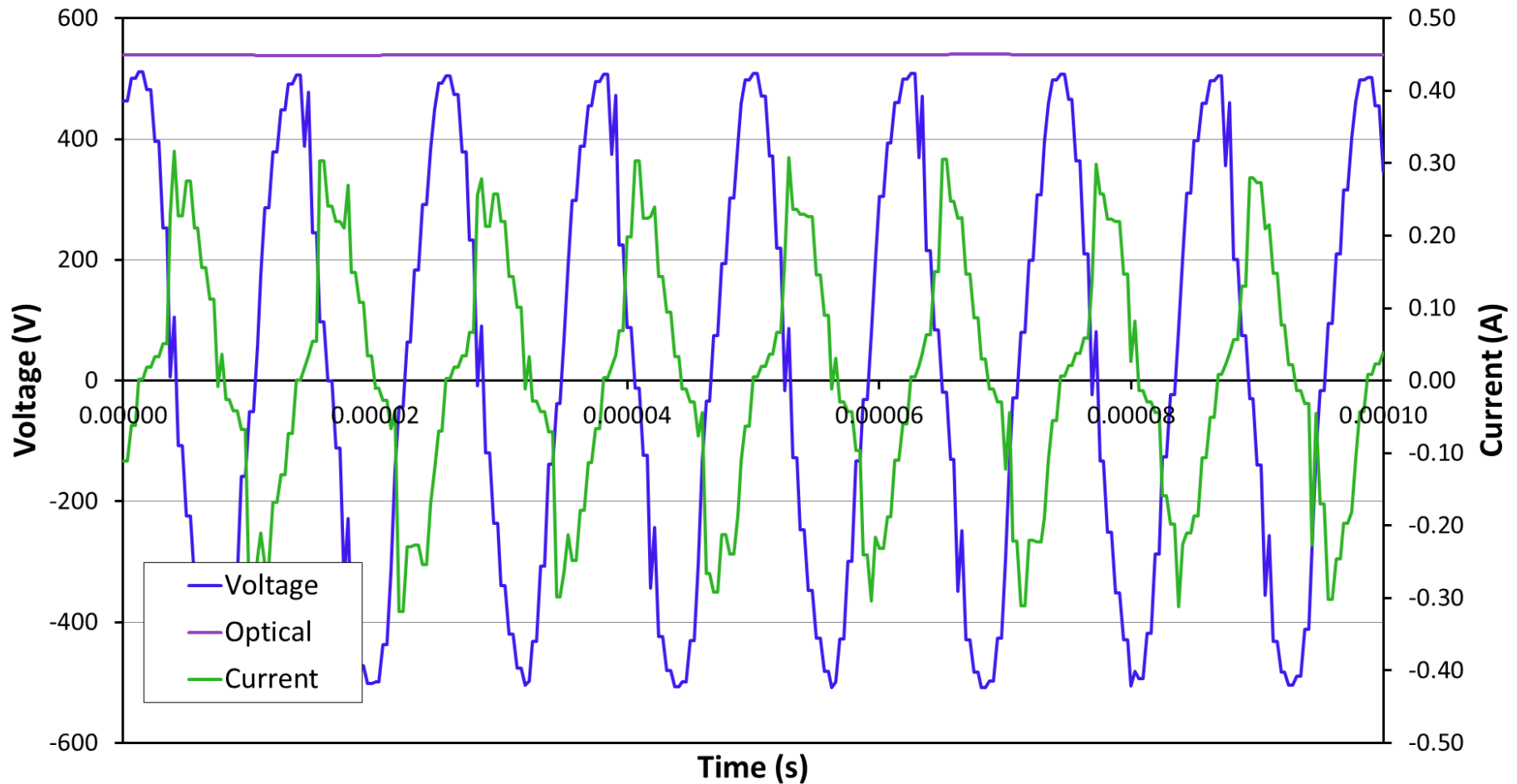

Transmitting 60 Hz AC electricity

60 Hz Sinusoidal

$L = 0.56 \mu\text{H}/\text{ft}$ 14 gauge

$C = 23.8 \text{ pF}/\text{ft}$ 14 gauge



$$Z = R + jX$$

Impedance = Resistance + Reactance

$$X = X_L - X_C \\ = 2\pi fL - \frac{1}{2\pi fC}$$

NIST Sphere System
25 ft – 14 gauge wire

NIST Sphere wiring

$$X = 2\pi fL - \frac{1}{2\pi fC}$$

$$L = 0.56 \mu\text{H/ft} \quad 14 \text{ gauge}$$

$$C = 23.8 \text{ pF/ft} \quad 14 \text{ gauge}$$

60 Hz Sinusoidal

$$\begin{aligned} X_L &= 2\pi (60 \text{ Hz})(0.56 \mu\text{H/ft})(25 \text{ ft}) \\ &= 0.0053 \Omega \end{aligned}$$

$$100 \text{ mA} \rightarrow 0.0005 \text{ V}$$

$$\begin{aligned} X_C &= \frac{1}{2\pi (60 \text{ Hz})(0.56 \text{ pF/ft})(25 \text{ ft})} \\ &= 4.47 \times 10^6 \Omega \end{aligned}$$

$$120 \text{ V} \rightarrow 0.027 \text{ mA}$$

NIST Sphere wiring

$$X = 2\pi fL - \frac{1}{2\pi fC}$$

$$L = 0.56 \mu\text{H/ft} \quad 14 \text{ gauge}$$

$$C = 23.8 \text{ pF/ft} \quad 14 \text{ gauge}$$

80 kHz Sinusoidal

$$\begin{aligned} X_L &= 2\pi(80 \text{ kHz})(0.56 \mu\text{H/ft})(25 \text{ ft}) \\ &= 7.04 \Omega \end{aligned}$$

$$200 \text{ mA} \rightarrow 1.4 \text{ V}$$

$$\begin{aligned} X_C &= \frac{1}{2\pi(80 \text{ kHz})(0.56 \text{ pF/ft})(25 \text{ ft})} \\ &= 3.35 \times 10^3 \Omega \end{aligned}$$

$$350 \text{ V} \rightarrow 35.8 \text{ mA}$$

Why use 80kHz electricity?

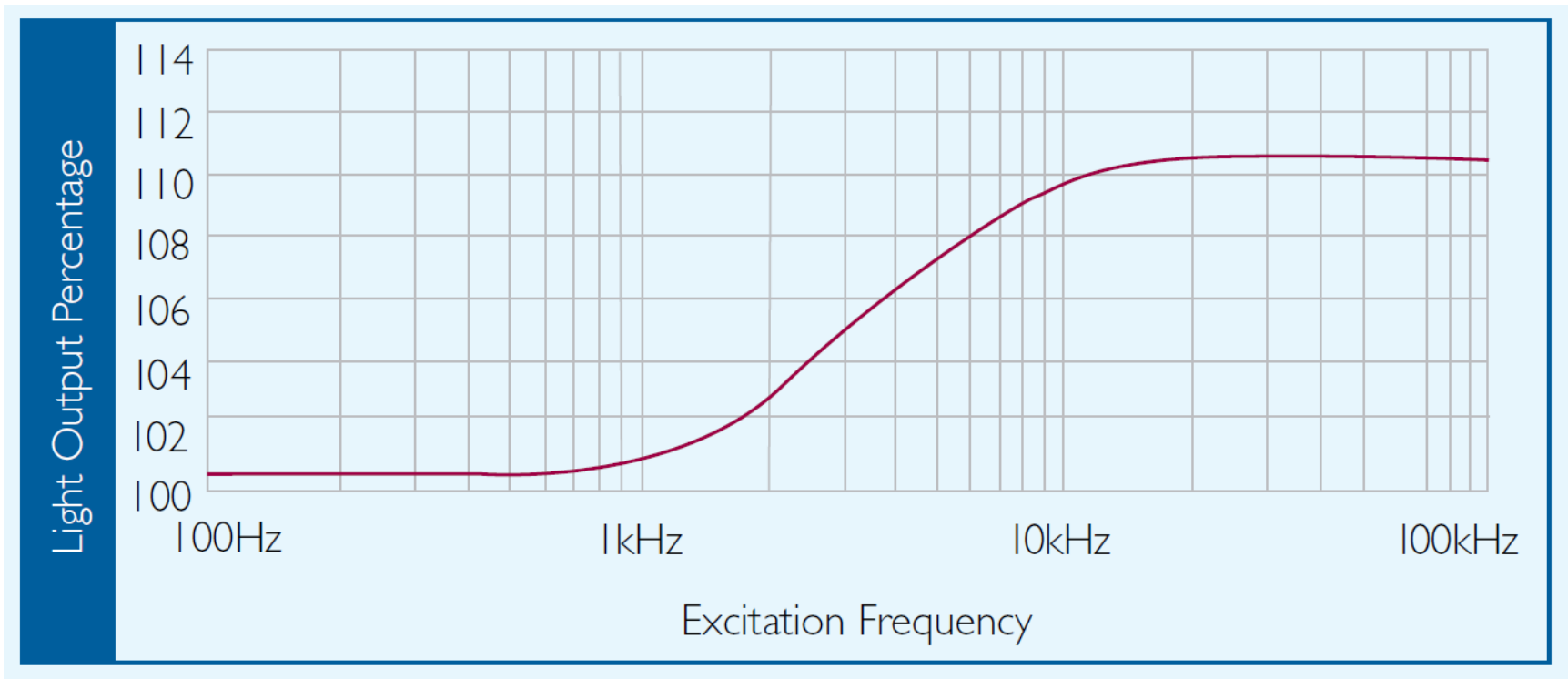

The ABC's of electronic fluorescent ballasts – PHILIPS Technical Note

38 NVLAP accredited labs – LM-9 (includes HF measurements)

Fluorescent lamp ballast

ANSI C82.3

7 Operating characteristics for 25 kHz

7.1 Rated supply voltage and frequency – The rated supply voltage and frequency of a reference ballast shall be in accordance with the values given on the relevant lamp data sheets in either ANSI C78.81 or ANSI C78.901.

7.2 Impedance – The following specifications apply to measurements made at rated input voltage and rated frequency of the HF reference ballast and with a room temperature of $25\text{ }^{\circ}\text{C} \pm 5\text{ }^{\circ}\text{C}$ and with stabilized temperature of the reference ballast. The impedance of an HF reference ballast shall have the value given on the relevant lamp data sheet in either ANSI C78.81 or ANSI C78.901, subject to the following tolerances:

- a) $\pm 0.5\%$ at the calibration current value;
- b) $\pm 1\%$ at any other value of current between 50% and 115% of the calibration current.

The series inductance of a reference resistor shall be less than 0.1 mH and its parallel capacitance shall be less than 1 nF.

Fluorescent lamp ballast

ANSI C82.3

7 Operating characteristics for 25 kHz

7.3 Power supply – The HF voltage supply used for the adjustment of or test with the HF reference ballast shall be such that a full load the rms summation of the harmonic contents shall not exceed 3% of the fundamental component.

This supply shall be a steady and free from sudden changes as possible. For best results the voltage should be regulated to within 0.2 %.

For resistor type reference ballasts the frequency shall be within 2 %; for choke type reference ballasts the frequency shall be within 0.5 %.

7.4 Instruments – All instruments used in HF reference ballast measurements should be suitable for high frequency operation. Details are under consideration.

What effects the transmission?

Capacitance

Material	ϵ
ECTFE – Halar	2.60
PFA Teflon	2.15
PVC	5.00
Polyethylene	2.29
Polypropylene	2.25
Rubber, butyl	4.0
Rubber, silicone	3.1
TFE Teflon	2.1
Teflon	2.10
Air	1.0

$$C = \frac{2.2\epsilon}{\log \left[\frac{1.3(D)}{(f)(d)} \right]} \text{ pF/ft}$$

ϵ – insulation dielectric constant

f – stranding factor

d – diameter of the conductor, inches

D – diameter over the insulation, inches

No. of Strands	f
1	1.000
7	0.939
19	0.970
37	0.980
61	0.985

Test hypothesis

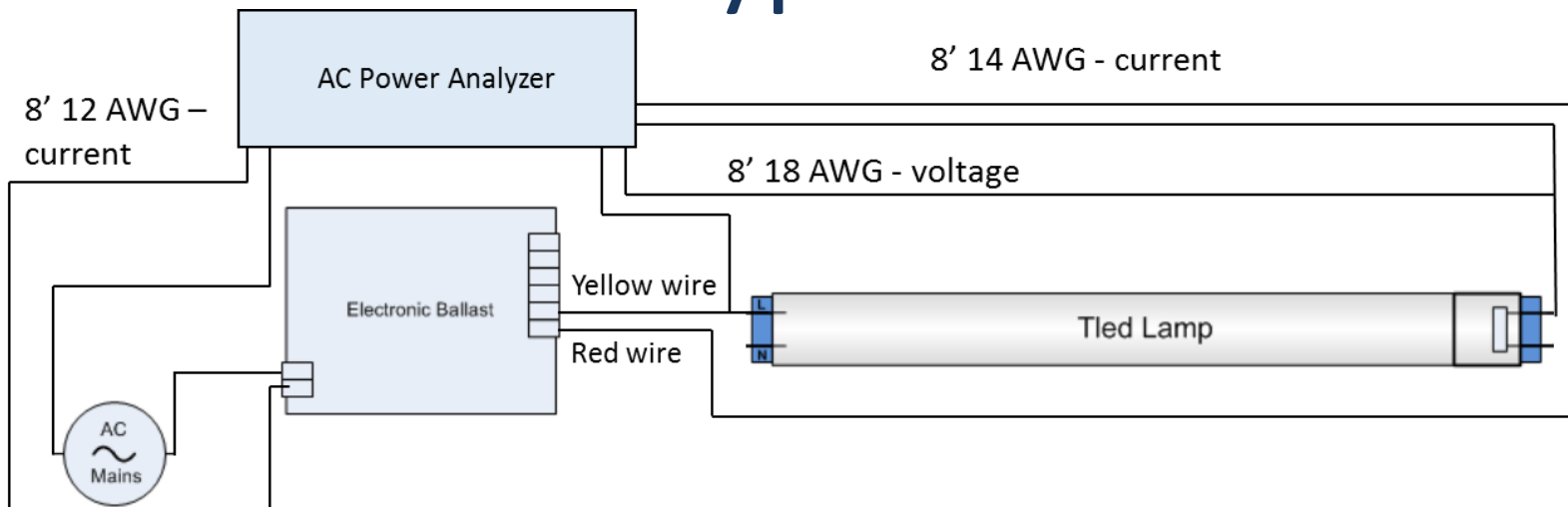

Condition	Voltage	Current	Power	PF
Standard	120.1 V	218.5 mA	25.74 W	0.9813
	342.8 V	163.2 mA	20.90 W	0.3738
+ 8' single to yellow	120.1 V	218.6 mA	25.76 W	0.9811
	342.6 V	164.4 mA	20.90 W	0.3711
+ 12' parallel to yellow and red	120.1 V	211.2 mA	24.82 W	0.9784
	317.8 V	150.2 mA	18.56 W	0.3885
+ 32' parallel to yellow and red	120.1 V	187.2 mA	21.90 W	0.9748
	292.6 V	131.5 mA	15.26 W	0.3968

Bad lamp – right?

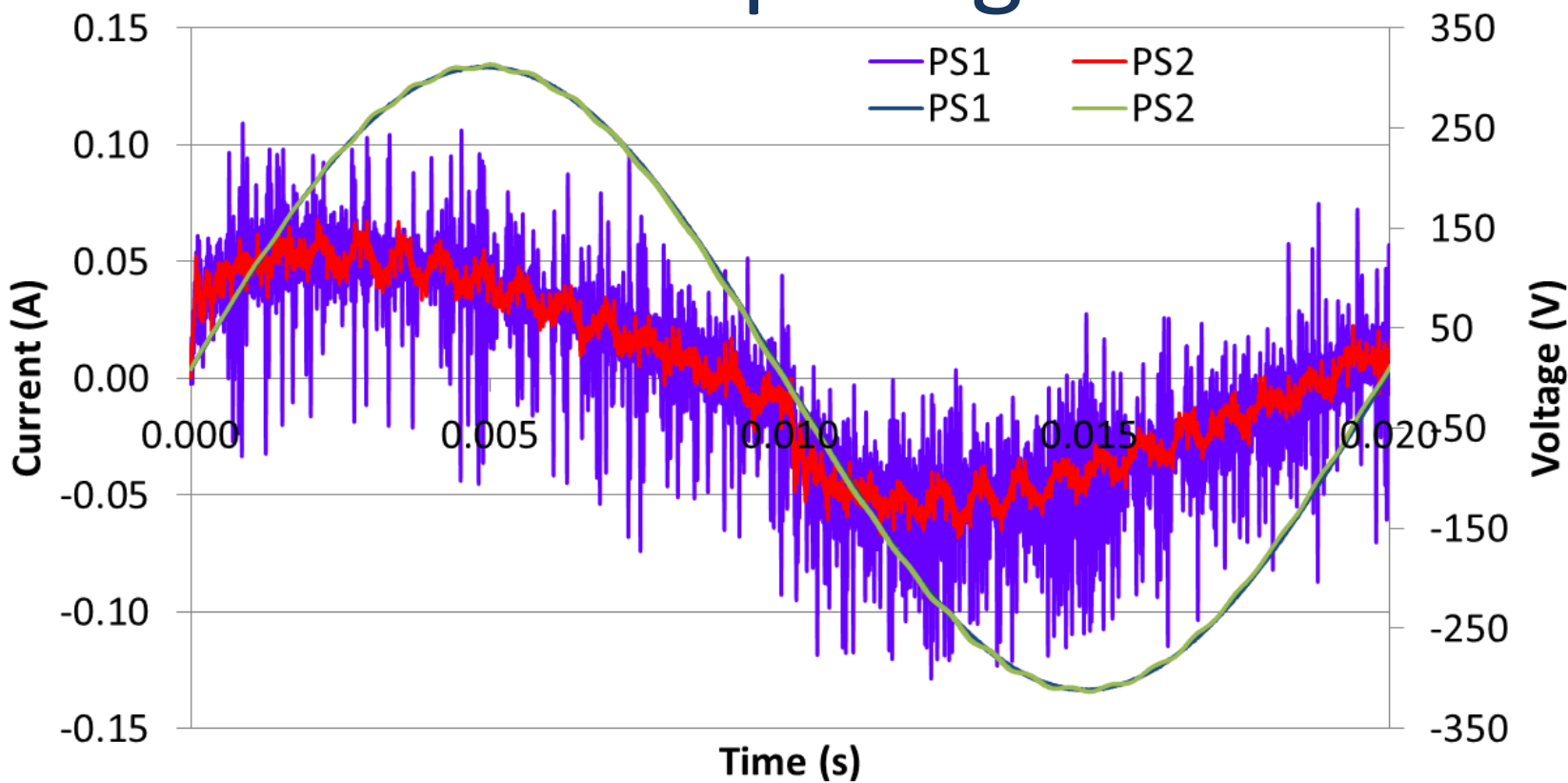

	Voltage	Current	Power	PF
PS1	220.0	0.03385	7.203	0.8429
PS2	220.0	0.03764	7.203	0.8698
		3.12 %	0.00 %	3.09 %

Another bad lamp

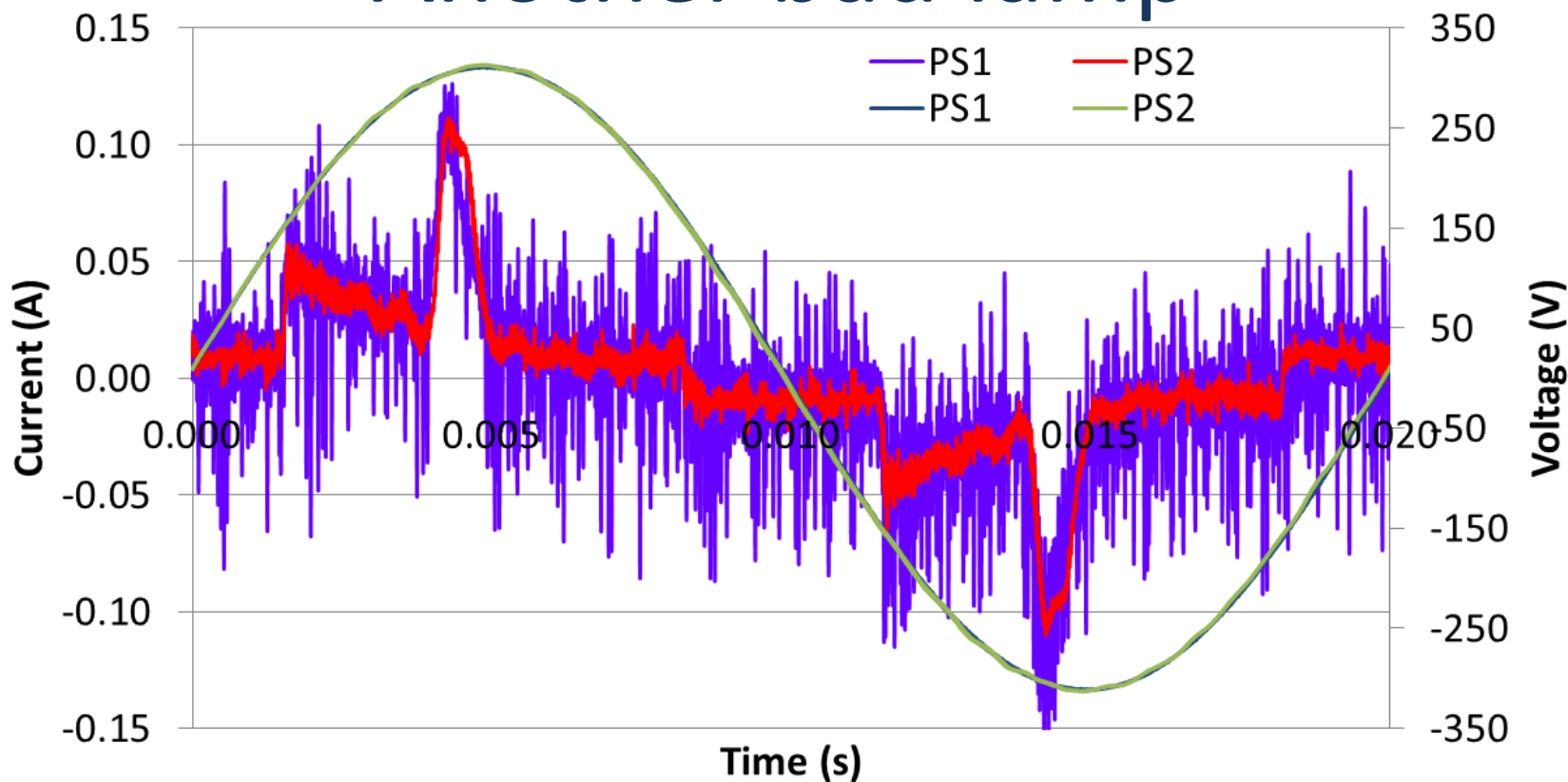

	Voltage	Current	Power	PF
PS1	220.0	0.03172	4.880	0.6995
PS2	220.1	0.03081	4.882	0.7201
		2.88 %	0.00 %	-2.94 %

Common SSL product

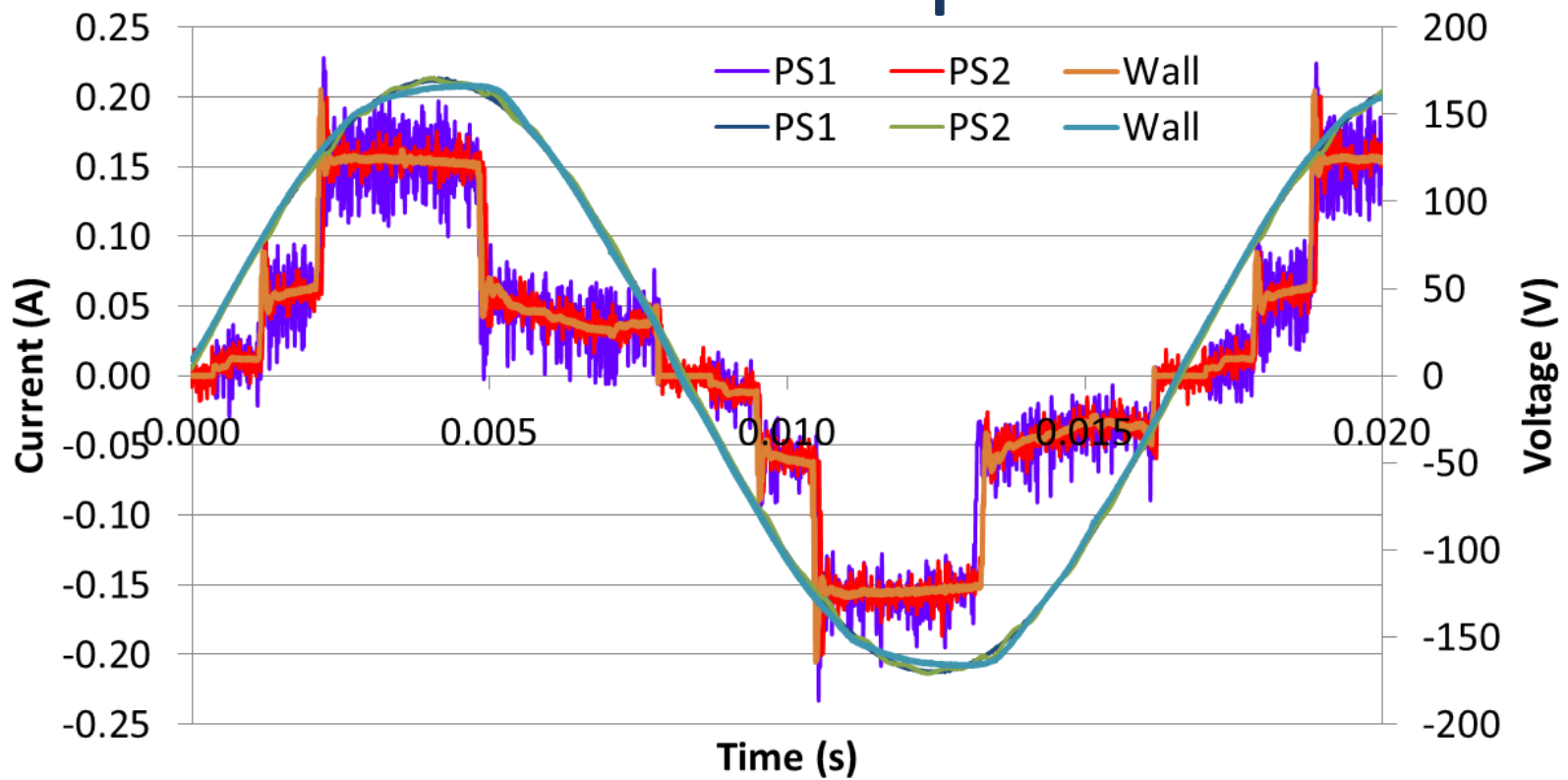

	Voltage	Current		Power		PF	
Wall	120.1	0.09620		10.638		0.9210	
PS1	120.0	0.09580	0.61 %	10.598	0.80 %	0.9194	0.0016
PS2	120.1	0.09561	0.42 %	10.553	0.38 %	0.9217	-0.0007

Free space wires result

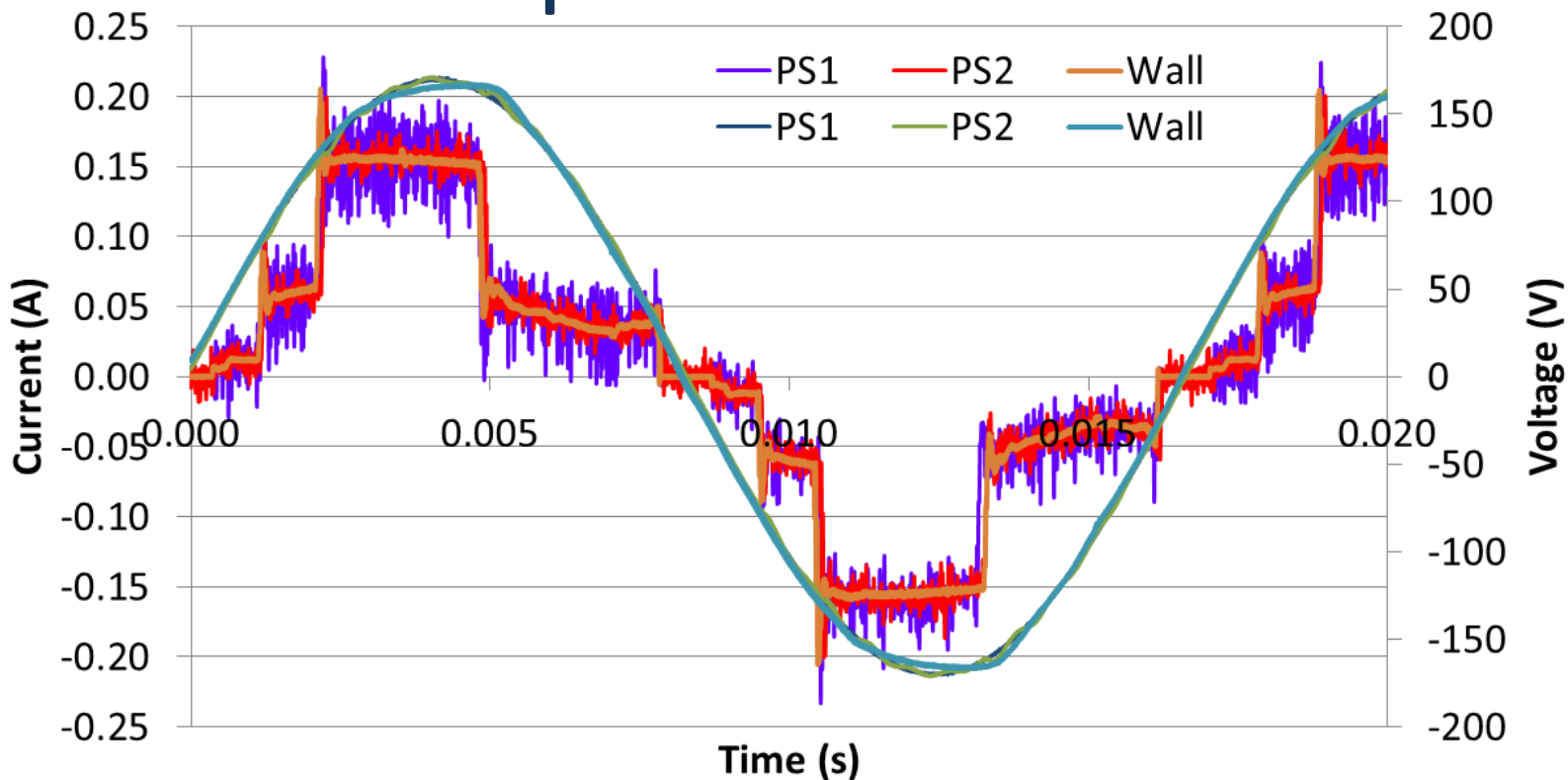

	Voltage	Current		Power		PF		Lumen	
Wall	120.05	0.09502		10.376		0.9097		823.03	
PS1	120.06	0.09508	-0.06 %	10.366	0.10 %	0.9080	0.0018	821.00	0.25 %
PS2	120.00	0.09510	-0.08 %	10.391	-0.15 %	0.9106	-0.0010	822.39	0.08 %

My nemesis lamp – free wires

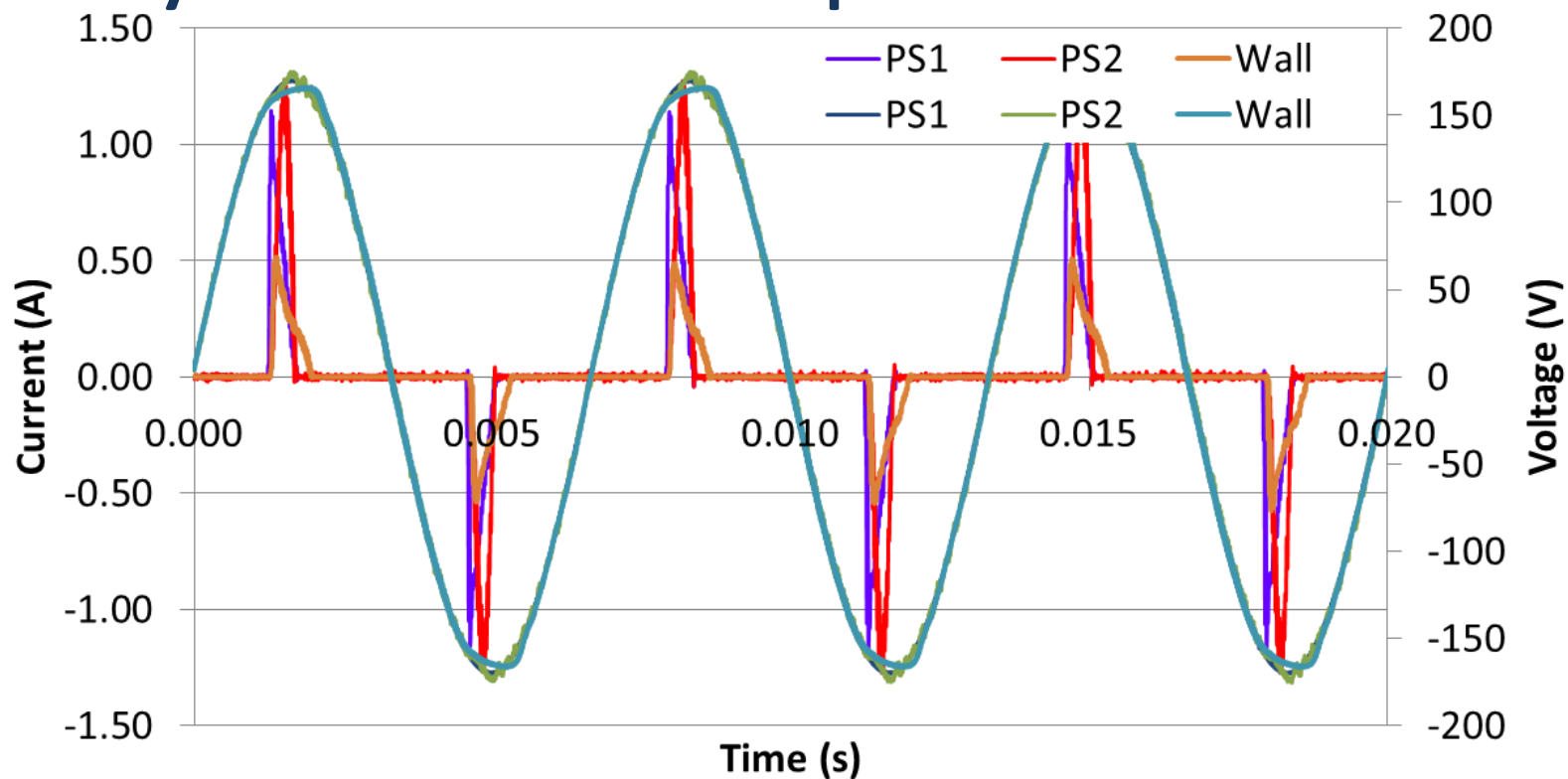

	Voltage	Current		Power		PF		Lumen	
Wall	120.04	0.1582		10.26		0.5399		293.5	
PS1	120.05	0.2315	-46.3 %	12.29	-19.8 %	0.4422	0.1810	327.1	-11.4 %
PS2	120.00	0.2841	-79.5%	14.73	-43.6 %	0.4321	0.1997	360.8	-22.9 %

Proposed LM-79 solution

NEMA 410 – Total line impedance 410 mΩ and 100 μH survey of input line characteristics of typical office buildings

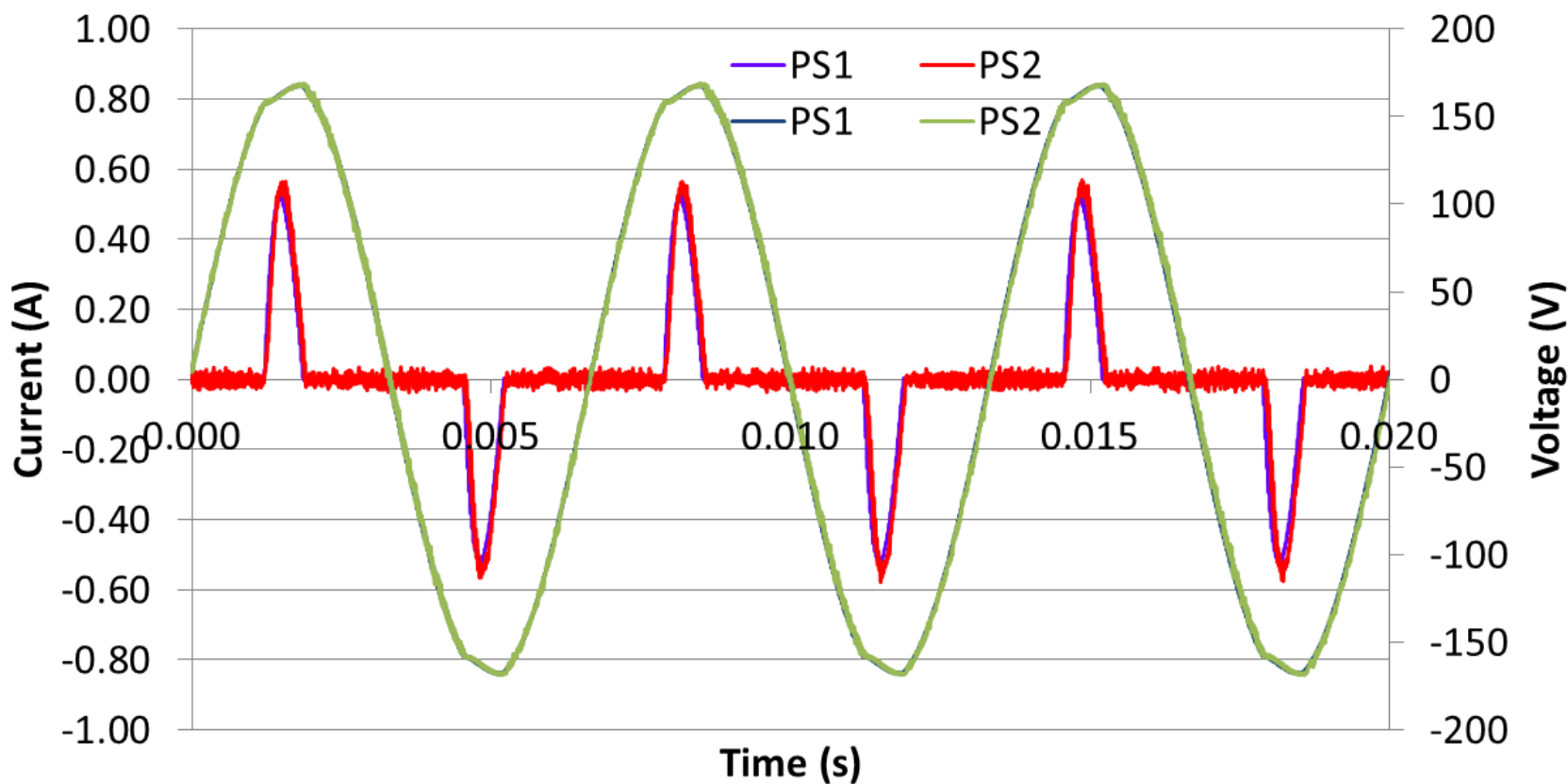

11 Ω and 100 μH

Effect on nemesis and other lamps

Nemesis

	Voltage	Current		Power		PF		Lumen	
Wall	120.04	0.1582		10.26		0.5399		293.5	
PS1	120.01	0.1651		10.84		0.5473		304.4	
PS2	120.01	0.1712	3.7 %	11.23	3.6 %	0.5468	-0.0010	309.3	1.6 %

W type

	Voltage	Current		Power		PF		Lumen	
Wall	120.05	0.09502		10.376		0.9097		823.03	
PS1	120.06	0.09508	-0.06 %	10.366	0.10 %	0.9080	0.0018	821.00	0.25 %
PS2	120.00	0.09510	-0.08 %	10.391	-0.15 %	0.9106	-0.0010	822.39	0.08 %
	11 mΩ and 100 μH								
PS1	120.08	0.09492		10.365		0.9094			
PS2	120.02	0.09489	-0.03 %	10.352	-0.13 %	0.9091	-0.0004	823.69	

Effect on other lamps

	Voltage	Current	Power	PF	Lumen
PS1	119.96	0.08040	9.355	0.9699	787.4
PS2	120.05	0.08038	9.353	0.9692	787.0
	11 mΩ and 100 μH				
PS1	119.99	0.08038	9.353	0.9698	787.1
PS2	119.99	0.08049	9.354	0.9685	787.1

C type

G type

	Voltage	Current	Power	PF	Lumen
PS1	120.07	0.0765	6.803	0.7404	381.5
PS2	120.02	0.0766	6.800	0.7394	381.5
	11 mΩ and 100 μH				
PS1	120.05	0.0753	6.804	0.7527	381.6
PS2	120.02	0.0753	6.801	0.7520	381.8

Thank you

Questions?